

# JANE

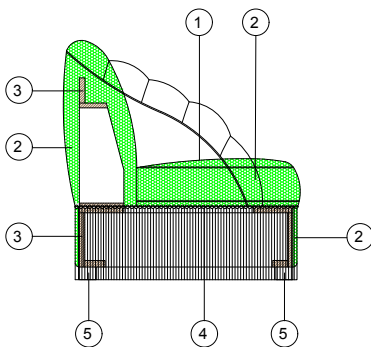

## MATERIALI / MATERIALS

- |  |   |
|--|---|
| 1 - tessuto - pelle  | 1 - fabric - leather  |
| 2 - poliuretano espanso indeformabile di diverse densità e uno strato di fibra di dacron® 100 gr | 2 - high resiliency polyurethane foam of different densities and dacron® fiber 100 gr layer |
| 3 - telaio in multistrato e agglomerato di legno   | 3 - structural frame in plywood   |
| 4 - cinghie elastiche intrecciate  | 4 - elastic webbing   |
| 5 - piedi P 59   | 5 - feet P 59   |

## PIEDI / FEET



P 59 h 4.5 cm  
Piedi in legno  
tinto wengè  
Wengè stained  
wooden feet

## SFODERABILITÀ COVER REMOVAL



STANDARD  
Non sfoderabile  
Non-removable cover

## IMBOTTITURA PADDING



STANDARD  
Non ignifuga  
Non-fire-retardant

## FINITURE BASE / BASE FINISHINGS



Con frangia  
With fringe



Senza frangia  
Without fringe

## CHIODINI METALLICI / METAL NAILS



130-1/3 ø 13  
Bronzo sfumato  
Shaded bronze



100-1/3 ø 10  
Cromo lucido  
Polished chrome



130-1/3 ø 13  
Oro invecchiato  
Aged golden



100-1/3 ø 10  
Oro lucido  
Polished gold

## FRANGE ORGANZINO H 26 CM / ORGANZINO FRINGE H 26 CM

### Di serie / Included



2R - STD

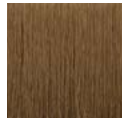

254R - STD

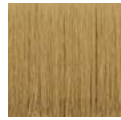

9R - STD

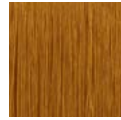

10R - STD

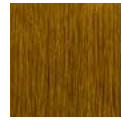

11R - STD

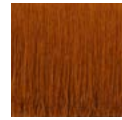

29R - STD

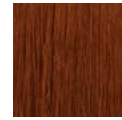

57R - STD



34R - STD

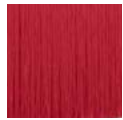

18R - STD



16R - STD



72R - STD



38R - STD



53R - STD

### Optional



0R - OPT



1R - OPT



203R - OPT



3R - OPT



5R - OPT



6R - OPT



7R - OPT



58R - OPT



14R - OPT



15R - OPT



56R - OPT

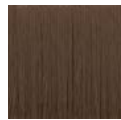

31R - OPT



32R - OPT



35R - OPT



36R - OPT



64R - OPT



63R - OPT



252R - OPT



19R - OPT



20R - OPT



220R - OPT



79R - OPT



30R - OPT



28R - OPT

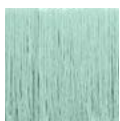

69R - OPT



208R - OPT



8R - OPT



17R - OPT



12R - OPT



27R - OPT



65R - OPT



66R - OPT



71R - OPT



70R - OPT



45R - OPT



24R - OPT



26R - OPT

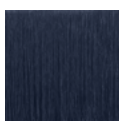

48R - OPT



52R - OPT



42R - OPT



51R - OPT



251R - OPT





50R - OPT

# JANE

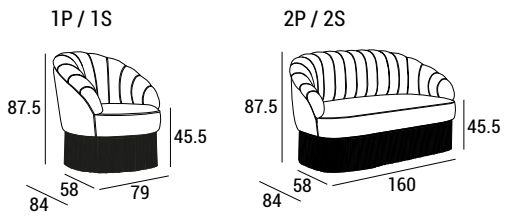
## DIMENSIONI / DIMENSIONS



## INFORMAZIONI TECNICHE / TECHNICAL DETAILS

			 tessuto / fabric mtl H 140 cm	 pelle / leather m <sup>2</sup>
1P / 1S	XX	0.65	5.50	10.23
2P / 2S	XX	1.29	8.00	14.88

# JANE

---

## PHOTO GALLERY



Jane 1P senza frangia  
1S without fringe



Jane 1P con frangia  
1S with fringe



Jane 2P con frangia  
1S with fringe

